

## Lista de Recambios / Spare part list

**Nº Ident / Ident-no** 006600110  
**Nombre / term** CIVIC V3 - 3P Integrado



**Cliente / customer**

**Proyecto / project**

**Fecha / stand** November 2013



# Lista de Recambios / Spare part list

Nº Ident / Ident-no 006600110  
Nombre / term CIVIC V3 - 3P Integrado







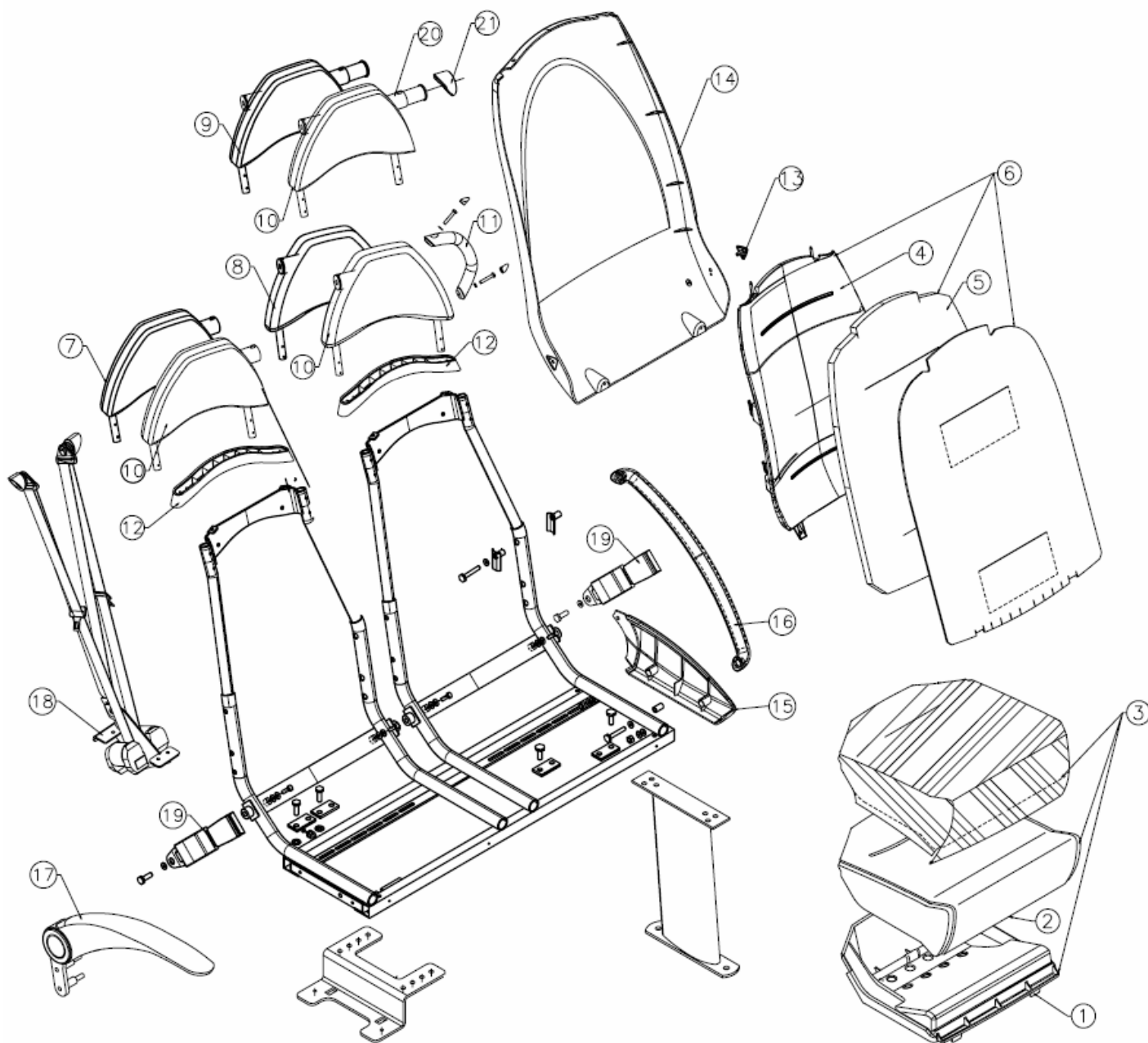

Cliente / customer











Proyecto / project



Fecha / stand November 2013



Nº	Referencia	Foto/Photo	Denominación	Description	Comentarios/Remarks
Nr	Part no.				
1	006640405		Fondo cojin	Cushion pan	
2	006610402		Espuma cojin	Cushion foam	
3	0066044XX		Cojin tapizado	Trimmed cushion	Facilitar nº obra y posicion / Body number and position is required
4	006640451		Fondo respaldo	Backrest squab	
5	006611303		Espuma respaldo	Backrest Foam	
6	0066043XX		Respaldo tapizado	Trimmed backrest	Facilitar nº obra y posicion / Body number and position is required
7.1	006602505		Cabezal 3P sin asa para butaca izda	3P Headrest without handle for left seat	
7.2	006602506		Cabezal 3P sin asa para butaca dcha	3P Headrest without handle for right seat	
8.1	006602513		Cabezal 3P con asa en la izda	3P Headrest with handle in the left	
8.2	006602514		Cabezal 3P con asa en la dcha	3P Headrest with handle in the right	

Nº	Referencia	Foto/Photo	Denominación	Description	Comentarios/Remarks
9.1	006602509	Not photo	Cabezal 3P con brida 33mm en la izda	3P Headrest with 33mm handpole connector in the left	
9.2	006602510	Not photo	Cabezal 3P con brida 33mm en la dcha	3P Headrest with 33mm handpole connector in the right	
9.3	006602511	Not photo	Cabezal 3P con brida 35mm en la izda	3P Headrest with 35mm handpole connector in the left	
9.4	006602512	Not photo	Cabezal 3P con brida 35mm en la dcha	3P Headrest with 35mm handpole connector in the right	
10	0066045XX		Cabezal tapizado	Trimmed headrest	Facilitar nº obra y posicion del asa o brida / Body number and handle or handpole conector position is required
11.1	0066404135N50- KIT		Asa cabezal negra	Black headrest handle	
11.2	0066404135A01- KIT		Asa cabezal amarilla	Yellow headrest handle	
12	006640417		Embellecedor cabezal	Headrest trimming	
13	006640901		Triangulo logotipo	Logo triangle	Lote mínimo/Minimun batch: 10 un.
14	006640402-G07		Carcasa Respaldo	Backrest shell	

Nº	Referencia	Foto/Photo	Denominación	Description	Comentarios/Remarks
Nr	Part no.				
15.1	0066404101-G07		Cacha lateral izda	Left side cover	
15.2	0066404102-G07		Cacha lateral dcha	Right side cover	
16.1	006602201		Brazo codera izdo	Left hip restraint	
16.2	006602202		Brazo codera dcho	Right hip restraint	
17.1	006607208		Brazo elevable completo dcho	Right foldable armrest	
17.2	006607209		Brazo elevable completo izdo	Left foldable armrest	
18.1	000699851		Carrete cinturon 3P izdo	Left 3P belt	Marca Lila
18.2	000699852		Carrete cinturon 3P dcho	Right 3P belt	Marca Gris
19.1	000699923		Hebilla pletina izda	Left buckle	
19.2	000699924		Hebilla pletina dcha	Right buckle	
19.3	000699920		Hebilla cinta	Buckle	

Nº	Referencia	Foto/Photo	Denominación	Description	Comentarios/Remarks
Nr	Part no.				
20.1	000699003		Soporte Brida 33mm	Handpole connector 33mm	
20.2	000699004		Soporte Brida 35mm	Handpole connector 35mm	
21	006640004-N50		Tapa cabezal brida barra	Headrest tap for handpole connector	