

Lista de Recambios / Spare part list

Nº Ident / Ident-no 008500100

Nombre / term Irati CL



Cliente / customer

Proyecto / project

Fecha / stand February 2015



Lista de Recambios / Spare part list

Nº Ident / Ident-no 008500100

Nombre / term Irati CL









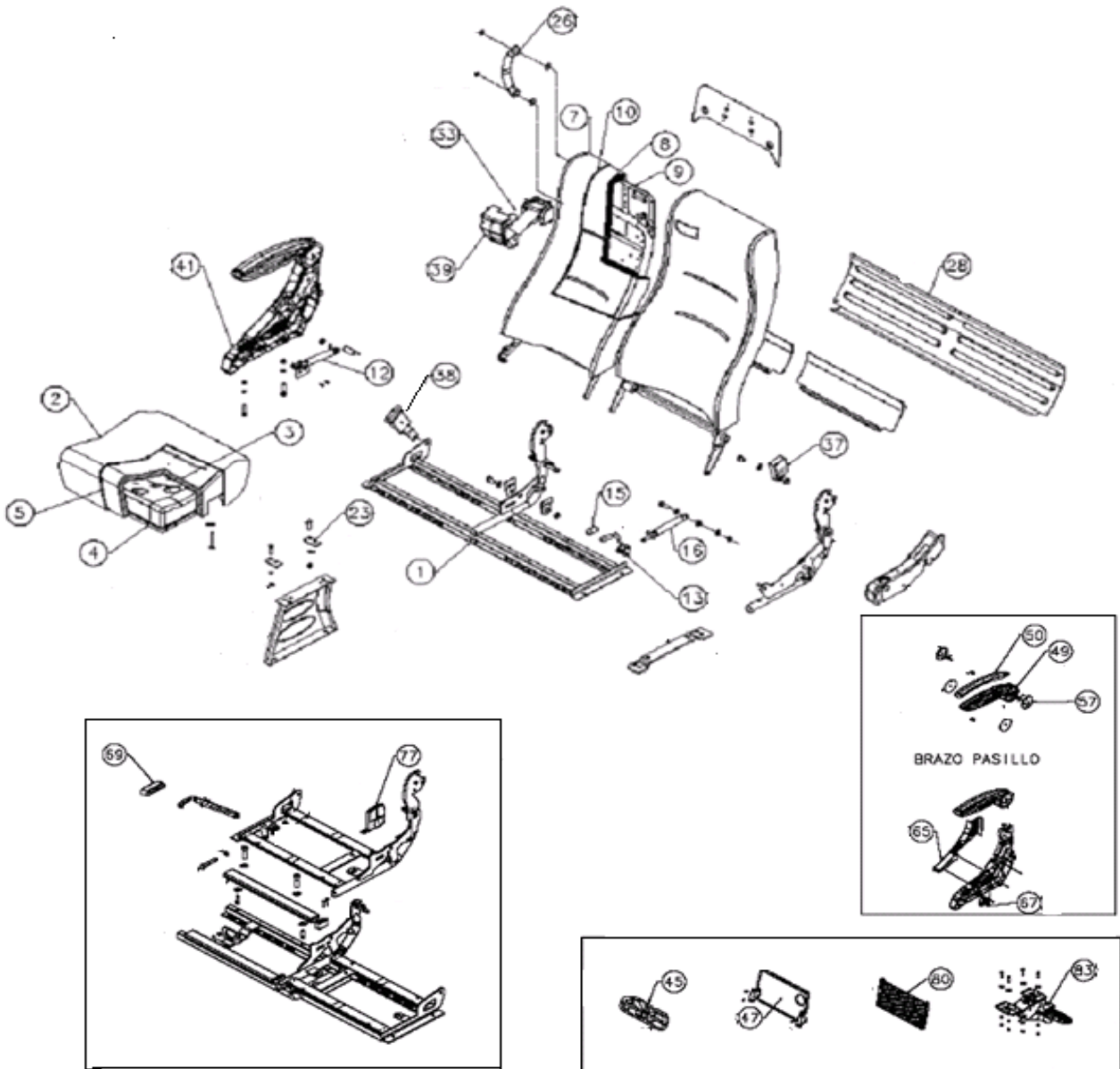

Cliente / customer







Proyecto / project













Fecha / stand February 2015



Nº	Referencia	Foto/Photo	Denominación	Description	Comentarios/Remarks
Nr	Part no.				
1	Configurable		Bastidor	Frame	Facilitar nº obra y posicion / Body number and position is required
2.1	0085044410-CFG		Cojin tapizado pasillo	Aisle trimmed cushion	Facilitar nº obra y posicion / Body number and position is required
2.2	0085044420-CFG		Cojin tapizado ventana	Window trimmed cushion	Facilitar nº obra y posicion / Body number and position is required
3	008510401		Espuma de cojin	Cushion foam	
4	008540401		Carcasa de cojin	Cushion pan	
5.1	008503400-CFG	Not photo	Funda cojin pasillo	Aisle cover cushion	Facilitar nº obra y posicion / Body number and position is required
5.2	0085034300-CFG	Not photo	Funda cojin ventana	Window cover cushion	Facilitar nº obra y posicion / Body number and position is required
7.1	0085043500-CFG		Respaldo tapizado pasillo	Aisle trimmed backrest	Facilitar nº obra y posicion / Body number and position is required
7.2	0085043510-CFG		Respaldo tapizado ventana	Window trimmed backrest	Facilitar nº obra y posicion / Body number and position is required
8.1	006110310	Not photo	Espuma respaldo 2 puntos	Backrest foam for 2 points belt	
8.2	009810322	Not photo	Espuma respaldo 3 puntos derecha	Right backrest foam for 3 points belt	
8.3	009810323	Not photo	Espuma respaldo 3 puntos izquierda	Left backrest foam for 3 points belt	

Nº	Referencia	Foto/Photo	Denominación	Description	Comentarios/Remarks
Nr	Part no.				
9.1	0085013420N50-CFG	Not photo	Armadura respaldo pasillo	Aisle backrest frame	Facilitar nº obra y posicion / Body number and position is required
9.2	0085013430N50-CFG	Not photo	Armadura respaldo ventana	Window backrest frame	Facilitar nº obra y posicion / Body number and position is required
10.1	008503300-CFG	Not photo	Funda respaldo pasillo	Aisle cover backrest	Facilitar nº obra y posicion / Body number and position is required
10.2	0085033200-CFG	Not photo	Funda respaldo ventana	Window cover backrest	Facilitar nº obra y posicion / Body number and position is required
12	008506101		Kit mecanismo reclinacion pasillo	Aisle reclining kit	
13.1	002104004		Montaje reclinacion costado derecha	Right side reclining lever	
13.2	002104005		Montaje reclinacion costado izquierda	Left side reclining lever	
15	000040402		Pomo reclinacion costado	Side recline knob	
16	000699302		Resorte 500 N	Gas ram	
23	001265133		Pletina de refuerzo	Reinforcement plate	
26.1	000699414-N50		Asa lateral negra	Black lateral handle	
26.2	000699414-A01		Asa lateral amarilla	Yellow lateral handle	

Nº	Referencia	Foto/Photo	Denominación	Description	Comentarios/Remarks
Nr	Part no.				
28	002125103-G14	Not photo	Rodapiés 2 plazas sin tapizar	2p kit plate without upholstery	
33.1	000699835		Carrete 2 puntos	2P belt	
33.2	000699832		Carrete 3 puntos derecho	Right 3P belt	
33.3	000699833		Carrete 3 puntos izquierdo	Left 3P belt	
37	000699907		Hebilla ventana	Window buckle	
38	000699913		Hebilla pasillo	Aisle buckle	
39.1	009840408		Caja protección carrete derecho	Right roller protector box	
39.2	009840409		caja protección carrete izquierdo	Left roller protector box	
41.1	0085042630-001		Lateral izquierdo M-G14 ; P-G21	Left lateral M-G14 ; P-G21	Antes/Before 2014: 0085042630-003 M-G14 ; P-G27
41.2	0085042630-002		Lateral derecho M-G14 ; P-G21	Right lateral M-G14 ; P-G21	Antes/Before 2014: 0085042630-004 M-G14 ; P-G27
45.1	000699431-N50		Compacto asidero cenicero	Ashtray compact assy	Antes/Before 2010: 000699416
45.2	000699432-N50		Compacto asidero perchero	Hook compact assy	Antes/Before 2010: 000699418

Nº	Referencia	Foto/Photo	Denominación	Description	Comentarios/Remarks
Nr	Part no.				
45.3	000699435-N50		Compacto asidero tapa	Compact assy with tap	Antes/Before 2010: 000699429
47	008507807		Montaje mesita baja	Low table kit	Solo mesita/only table: 000699722-N50
49	008547201-G14		Cuerpo apoyabrazos	Armrest body	
50	008540201-G21		Almohadilla apoyabrazos	Armrest pillow	Antes/Before 2014: 008540201-G27
57	008540414-G21		Tapa apoyabrazos	Armrest cover	Antes/Before 2014: 008540414-G27
65.1	008540402-G21		Embelecedor lateral derecho	Right lateral tailpipe	Antes/Before 2014: 008540402-G27
65.2	008540404-G21		Embelecedor lateral para hebilla derecho	Right lateral tailpipe for buckle	Antes/Before 2014: 008540404-G27
65.3	008540403-G21		Embelecedor lateral izquierdo	Left lateral tailpipe	Antes/Before 2014: 008540403-G27
65.4	008540405-G21		Embelecedor lateral para hebilla izquierdo	Left lateral tailpipe for buckle	Antes/Before 2014: 008540405-G27
67.1	008566401		Pomo inclinacion izquierdo	Left reclining pommel	
67.2	008566402		Pomo inclinacion derecho	Right reclining pommel	
69	009940029-N50		Asidero palanca del desplazable	Lever handle for sliding frame	

Nº	Referencia	Foto/Photo	Denominación	Description	Comentarios/Remarks
Nr	Part no.				
77	008540701		Guia cinta doble	Double belt guide	
80.1	002107301		Montaje revistero "L"	"L" magazine kit	Solo revistero/ only "L" magazine: 000699701-N50
80.2	002107303		Montaje revistero red	Net magazine kit	Solo revistero/ only net magazine: 000699712-N50
83.1	003502507-KIT		Apoyapies 2 posiciones	2 position footrest	
83.2	003502508-KIT		Apoyapies 4 posiciones	4 position footrest	